

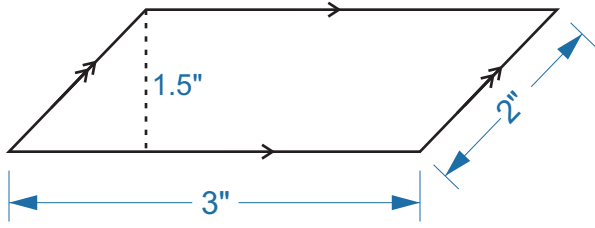

Find the area of each figure

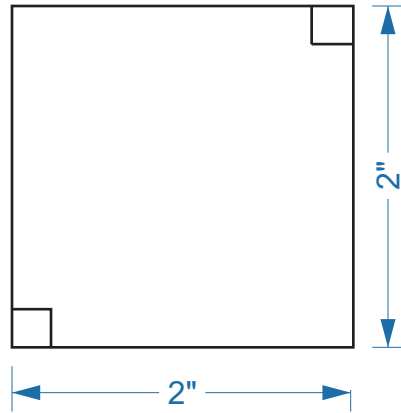

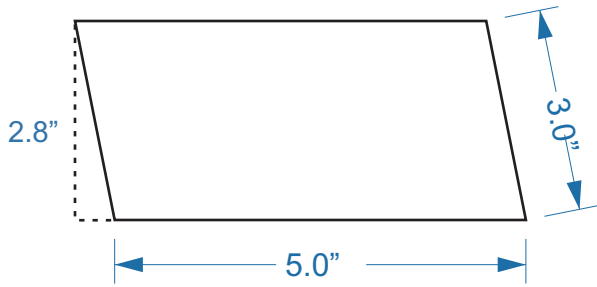



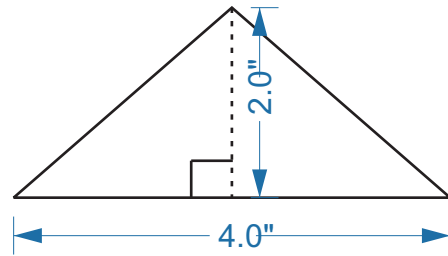

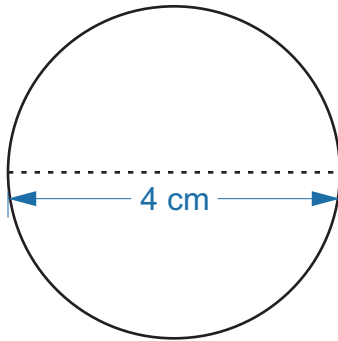

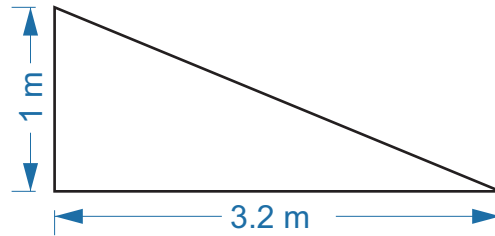

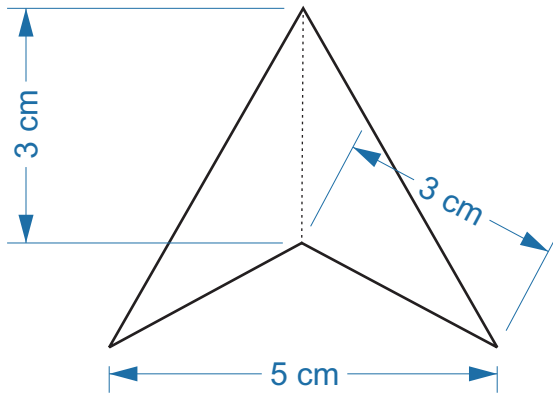

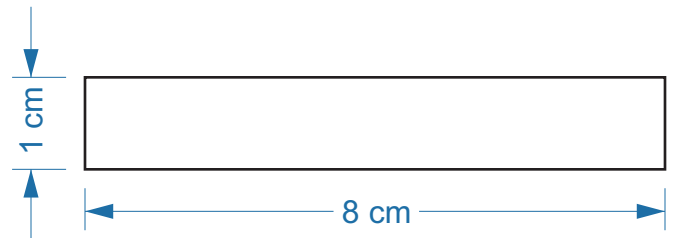



Find the area of each figure

